

190-620-000 (1998)
42" Snow Blade

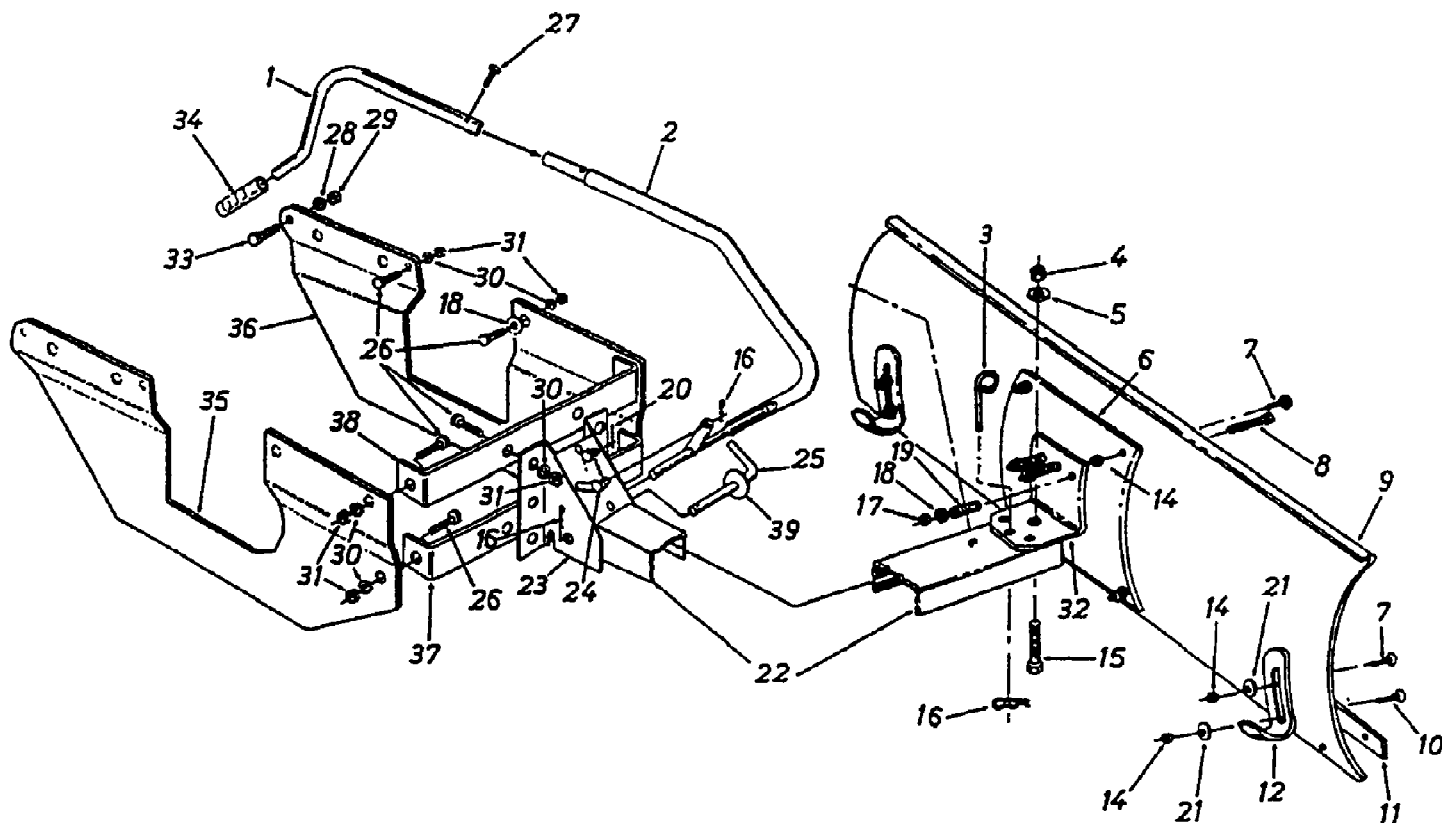

190-620-000 (1998)
42" Snow Blade

Page 2 of 2

Ref #	Part Number	Qty	S/P/F	Description
1	AF-46553	1		Upper Lift Handle New Part
2	AF-63283	1		Lift Handle Ass'y. New Part
3	AF-43038	1		Pivot Lock Pin
4	712-0384	1	S	Hex Cent. L-Nut 1/2-13 Thd.
5	736-0179	1	S	FI-Wash. 17/32" I.D.
6	AF-23061	1		Reinforcement Plate
7	710-0451	1	/P/F	Carriage Bolt 5/16-18 x .75" Lg.
8	AF-43036	1		Hex Bolt 3/8-16 x 4" Lg.
9	AF-23114	1		42" Blade
10	710-0276	1	/P/F	Carriage Bolt 5/16-18 x 1" Lg.
11	AF-23117	1		42" Wear Plate
12	20505	1		Shoe Skid
14	712-0158	1	S	Hex Cent. L-Nut 5/16-18 Thd.
15	710-0474	1	/P/F	Hex Bolt 1/2-13 x 1.25" Lg.
16	714-0101	1	S	Int. Cotter Pin
17	712-0375	1	/P	Hex Cent. L-Nut 3/8-16 Thd.
18	736-0258	1	/P	FI-Wash. 3/8" I.D.
19	AF-43035	1		Compression Spring
20	714-0121	1	S/F	Cotter Pin 1/8" Dia. x 1" Lg.
21	AF-43081	1		FI-Wash. 5/16" I.D.
22	AF-63284	1		Push Bar Channel
23	AF-24023	1	S	Pivot Support Bracket
24	AF-63034	1		Lift Link
25	AF-46065	1		Channel Pivot Shaft
26	710-0253	1	S	Hex Bolt 3/8-16 x 1" Lg. Grade 5
27	AF-44818	1	S	Hex Bolt #10 x 5/8" Lg.
28	736-0329	1	S/F	L-Wash. 1/4" I.D.
29	712-0287	1	S/F	Hex Nut 1/4-20 Thd.
30	736-0169	1	S/F	L-Wash. 3/8" I.D.
31	712-0798	1	/P/F	Hex Nut 3/8-16 Thd.
32	AF-23115	1		Support Bracket
33	710-0252	1	/P/F	Hex Bolt 1/4-20 x .75" Lg.
34	720-0204	1	/P	Rubber Grip
35	AF-24134	1		Frame Support Brkt. (R.H.)
36	AF-24133	1		Frame Support Brkt. (L.H.)
37	AF-24128	1	S	Support Brkt. (Lower)
38	AF-24132	1	S	Support Brkt. (Upper)
39	AF-R19171614	1		FI-Wash. 17/32" I.D. x 1" O.D.